

Varenummer: 2314451711
 Beskrivelse: E+G Aluminiums hjul 451711
 RE.F5-200-SSL-H Drejeligt konsol u/bremse

Mål

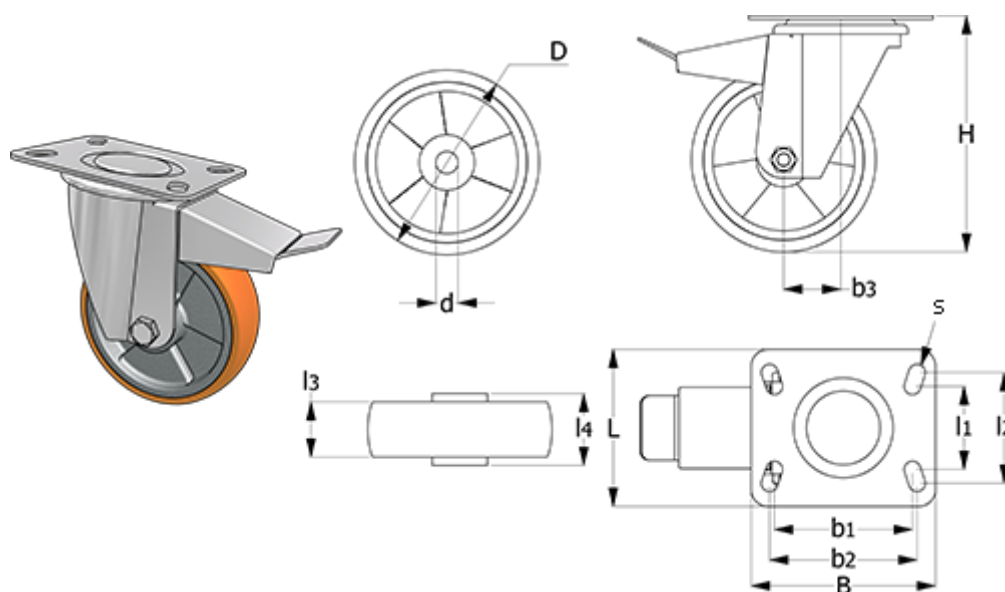

B	= 140	Kode	= 451711	Type	= RE.F5-200-SSL-H
b1	= 105	L	= 110	Vægt (g)	= 3940
b2	= 105	l1	= 73		
b3	= 70	l2	= 87		
D	= 200	l3	= 50		
d	= 25	l4	= 55		
Dynamisk belastning (N)	= 7500	Rullemodstand (N)	= 3600		
H	= 250	s	= 11		